

# Munari Mobile

Wooden doweling

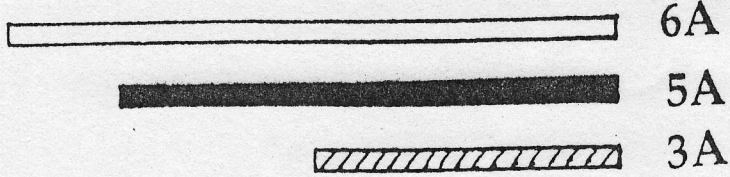

Reverse Sides of  
black & white pieces

$A =$  diameter of  
glass sphere



Glass  
Sphere

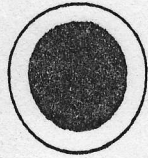

$B = A + \frac{1}{3}r$

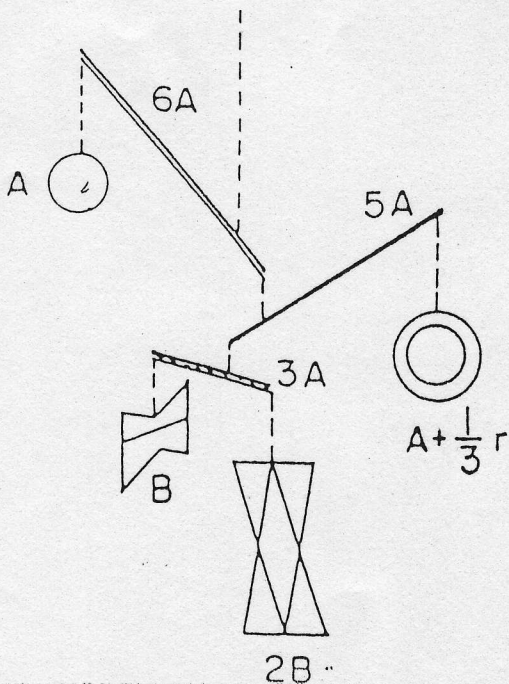
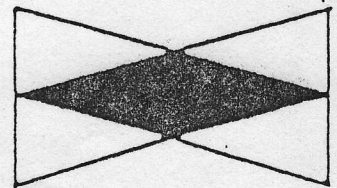
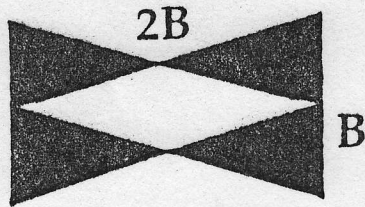
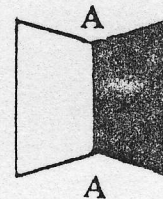
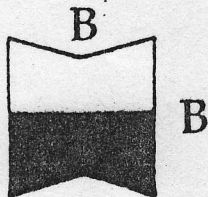
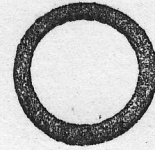

guidelines for hanging the mobile

